

SC Series Cabinets

Pre-Configured Cabinets V3 and V4

Features

- Available in two widths, four heights and five depths
- All welded 14 gauge steel tubing construction provides a 2000 lb. static load rating
- Seismic Zone 4 rated, UL listed
- 19" wide rack mount
- Mounting rails (2 pr. included) are cage nut style, punched on EIA 5/8-5/8-1/2" standard spacing and are fully adjustable front to rear. All are provided with M6 Cage Nuts and screws (bag of 50 each).
- Flush mounted removable side panels secured from inside of cabinet provide optimal security
- Lockable flush mount removable doors with Perforated or Plexiglas inserts are field reversible without tools
- Flush mount fan top allows for up to (4) 110 CFM fans to be placed in cabinet top for maximum cooling
- Open base for raised floor ventilation option
- Bottom corners gusseted with both seismic tie down and caster mount features
- Four point leveling
- Choice of colors: Color Code = "x" Black (BLK) or IBM White (W)

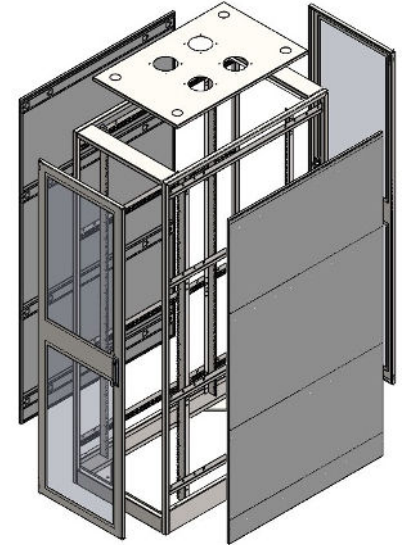

V3 Includes

- (1) Frame
- (2pr) Cage Nut Rails
- (2) Solid Side Panels
- (1) Top w/Fan Holes
- (2) Perforated Doors

V4 Includes

- (1) Frame
- (2pr) Cage Nut Rails
- (2) Solid Side Panels
- (1) Top w/Fan Holes
- (1) Plexiglas Door
- (2) Perforated Doors

Pre-Configured Part Numbers

V3 - Perf Doors	Outside Dimensions	RMU	Useable Depth	V4 - Plex & Perf Doors
SC48X24-V3x	24"W x 24"D x 48"H	23U	22"	SC48X24-V4x
SC48X30-V3x	24"W x 30"D x 48"H	23U	28"	SC48X30-V4x
SC48X36-V3x	24"W x 36"D x 48"H	23U	34"	SC48X36-V4x
SC48X42-V3x	24"W x 42"D x 48"H	23U	40"	SC48X42-V4x
SC48X48-V3x	24"W x 48"D x 48"H	23U	46"	SC48X48-V4x
SC72X24-V3x	24"W x 24"D x 72"H	37U	22"	SC72X24-V4x
SC72X30-V3x	24"W x 30"D x 72"H	37U	28"	SC72X30-V4x
SC72X36-V3x	24"W x 36"D x 72"H	37U	34"	SC72X36-V4x
SC72X42-V3x	24"W x 42"D x 72"H	37U	40"	SC72X42-V4x
SC72X48-V3x	24"W x 48"D x 72"H	37U	46"	SC72X48-V4x
SC78X24-V3x	24"W x 24"D x 78"H	42U	22"	SC78X24-V4x
SC78X30-V3x	24"W x 30"D x 78"H	42U	28"	SC78X30-V4x
SC78X36-V3x	24"W x 36"D x 78"H	42U	34"	SC78X36-V4x
SC78X42-V3x	24"W x 42"D x 78"H	42U	40"	SC78X42-V4x
SC78X48-V3x	24"W x 48"D x 78"H	42U	46"	SC78X48-V4x
SC84X24-V3x	24"W x 24"D x 84"H	44U	22"	SC84X24-V4x
SC84X30-V3x	24"W x 30"D x 84"H	44U	28"	SC84X30-V4x
SC84X36-V3x	24"W x 36"D x 84"H	44U	34"	SC84X36-V4x
SC84X42-V3x	24"W x 42"D x 84"H	44U	40"	SC84X42-V4x
SC84X48-V3x	24"W x 48"D x 84"H	44U	46"	SC84X48-V4x

Note: For wider (28") frame, add "-28" to part # e.g. SC84x36-V3-28BK

SC Series Cabinets Components

Frames

Features

- 19" and 23" wide rack mount
- Available in 4 heights and 5 depths
- All welded 14 gauge steel tubing provides a 2000 lb. static load rating
- Bottom corner gussets for caster mounts or seismic tie down points
- Frames are Seismic Zone 4 rated, UL Listed
- Choice of colors: Color Code ="x" Black (BLK) or IBM White (W)

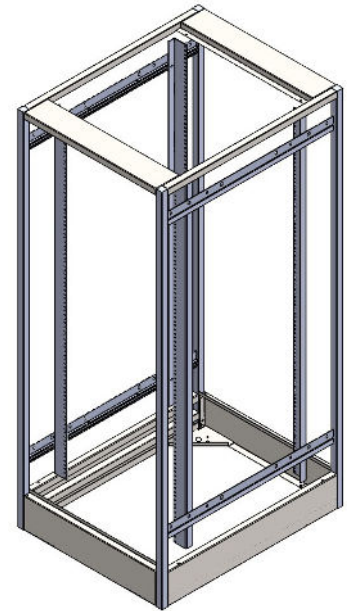

SC Series Frame

Mounting Rails

Features

- 12 gauge steel mounting rails available in Cage Nut (standard) or tapped versions
 - Cage Nut–Holes punched to accept Cage Nuts on EIA standard spacing
 - Tapped–Holes tapped #10-32 on EIA standard spacing
- 4" wide rails convert 28" wide frame to 19" rack mount (add "-4" to part number e.g. SWE730-CN-4)
- Sold separately in pairs–includes appropriate mounting hardware when ordered with cabinet frame

Frame & Mounting Rail Part Numbers (HxWxD)

Height	24" D	30" D	36" D	42" D	48" D	Mounting Rails
48"H (23U)	FR-A48X24X24x	FR-A48X24X30x	FR-A48X24X36x	FR-A48X24X42x	FR-A48X24X48x	Use SWE740-CN (Cage Nut) OR SWE740 (Tapped)
	FR-A48X28X24x	FR-A48X28X30x	FR-A48X28X36x	FR-A48X28X42x	FR-A48X28X48x	Use SWE740-CN (Cage Nut) OR SWE740 (Tapped)
72"H (37U)	FR-A72X24X24x	FR-A72X24X30x	FR-A72X24X36x	FR-A72X24X42x	FR-A72X24X48x	Use SWE700-CN (Cage Nut) OR WE700 (Tapped)
	FR-A72X28X24x	FR-A72X28X30x	FR-A72X28X36x	FR-A72X28X42x	FR-A72X28X48x	Use SWE700-CN (Cage Nut) OR SWE700 (Tapped)
78"H (42U)	FR-A78X24X24x	FR-A78X24X30x	FR-A78X24X36x	FR-A78X24X42x	FR-A78X24X48x	Use MR73.5-CN (Cage Nut) OR MR73.5 (Tapped)
	FR-A78X28X24x	FR-A78X28X30x	FR-A78X28X36x	FR-A78X28X42x	FR-A78X28X48x	Use MR73.5-CN (Cage Nut) OR MR73.5 (Tapped)
84"H (44U)	FR-A84X24X24x	FR-A84X24X30x	FR-A84X24X36x	FR-A84X24X42x	FR-A84X24X48x	Use SWE730-CN (Cage Nut) OR SWE730 (Tapped)
	FR-A84X28X24x	FR-A84X28X30x	FR-A84X28X36x	FR-A84X28X42x	FR-A84X28X48x	Use SWE730-CN (Cage Nut) OR WE730 (Tapped)

SC Series Cabinets Components

Doors

Features

- Flush mount doors are field reversible without tools, right to left hand swing
- Carbon steel all welded construction for strength
- Flush mounted lift and turn locking latches
- Optional Electronic Locks, Proximity Locks and Combo Locks available
- Optional Perforated, Split , Plexiglas, Vented or Solid versions
- Choice of colors: Color Code = "-x" Black (BLK) or IBM White (W)

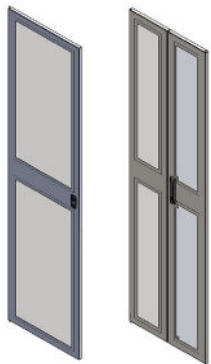

Perforated Doors



Solid Doors

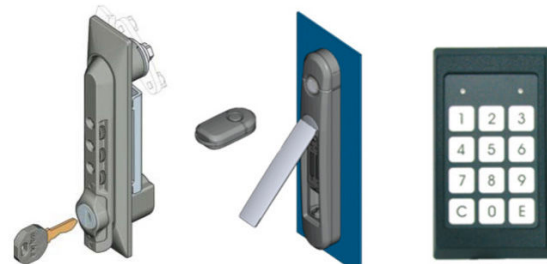

Lock Options

Door Style	48"H Frame	72"H Frame	78"H Frame	84"H Frame	Width
Perforated	DPRF-A42X22x	DPRF-A66X22x	DPRF-A72X22x	DPRF-A78X22x	24"
	DPRF-A42X26x	DPRF-A66X26x	DPRF-A72X26x	DPRF-A78X26x	28"
Split Perforated	DPRF-A42X22-2x	DPRF-A66X22-2x	DPRF-A72X22-2x	DPRF-A78X22-2x	24"
	DPRF-A42X26-2x	DPRF-A66X26-2x	DPRF-A72X26-2x	DPRF-A78X26-2x	28"
Plexiglas	DPLX-A42X22x	DPLX-A66X22x	DPLX-A72X22x	DPLX-A78X22x	24"
	DPLX-A42X26x	DPLX-A66X26x	DPLX-A72X26x	DPLX-A78X26x	28"
Solid	DSTL-A42X22x	DSTL-A66X22x	DSTL-A72X22x	DSTL-A78X22x	24"
	DSTL-A42X26x	DSTL-A66X26x	DSTL-A72X26x	DSTL-A78X26x	28"
Vented	DSTLV-A42X22x	DSTLV-A66X22x	DSTLV-A72X22x	DSTLV-A78X22x	24"
	DSTLV-A42X26x	DSTLV-A66X26x	DSTLV-A72X26x	DSTLV-A78X26x	28"

SC Series Cabinets Components

Side Panels

Features

- Flush mount side panels secured from inside for optimum security
- Constructed from carbon steel
- Optional Quick Release locking latches available
- Optional solid or vented versions
- Choice of colors: Color Code = "x" Black (BLK) or IBM White (W)

Height	24"D Frame	30"D Frame	36"D Frame	42"D Frame	48"D Frame
48"H (23U)	SP-A42X22x	SP-A42X28x	SP-A42X34x	SP-A42X40x	SP-A42X46x
72"H (37U)	SP-A66X22x	SP-A66X28x	SP-A66X34x	SP-A66X40x	SP-A66X46x
78"H (42U)	SP-A72X22x	SP-A72X28x	SP-A72X34x	SP-A78X40x	SP-A78X46x
84"H (44U)	SP-A78X22x	SP-A78X28x	SP-A78X34x	SP-A78X40x	SP-A78X46x

Note: Add "V" to part number for Vented e.g. SP-A42X22-VBLK

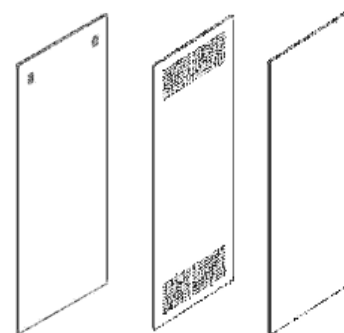

Side Panels

SC Series Cabinets Components

Cabinet Tops

Features

- Flush mount tops available in 3 styles for 24" wide and 28" wide frames:
 - Top with Fan Holes
 - Solid
 - Perforated
- Fan tops have (4) fan holes for 30"D, 36"D, 42"D and 48"D frames
- Fan tops for 24"D cabinets have (2) fan holes
- Fan holes have easily removable covers when fans not required
- Solid and Fan Tops have cable entry knockouts in each corner

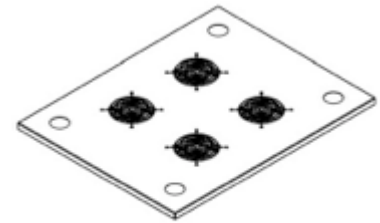

Flush Mount Fan Top

Top Style	24" Deep	30" Deep	36" Deep	42" Deep	48" Deep
Fan Top	FMT-A22X16-FHx	FMT-A22X22-FHx	FMT-A22x28-FHx	FMT-A22X34-FHx	FMT-A22X40-FHx
	FMT-A26X16-FHx	FMT-A26X22-FHx	FMT-A26x28-FHx	FMT-A26X34-FHx	FMT-A26X40-FHx
Solid Top	FMT-A22X16x	FMT-A22X22x	FMT-A22X28x	FMT-A22X34x	FMT-A22X40x
	FMT-A26X16x	FMT-A26X22x	FMT-A26X28x	FMT-A26X34x	FMT-A26X40x
Perforated Top	FMT-A22X16-PRFx	FMT-A22X22-PRFx	FMT-A22X28-PRFx	FMT-A22X34-PRFx	FMT-A22X40-PRFx
	FMT-A26X16-PRFx	FMT-A26X22-PRFx	FMT-A26X28-PRFx	FMT-A26X34-PRFx	FMT-A26X40-PRFx

Bottoms

Features

- Available for 24"W and 28"W cabinets in 5 depths
- 24"D versions have (2) covered fan holes, deeper versions have (4) covered fan holes (part # 19155K23 if filter is required for fan hole)
- Includes cable entry holes with covers

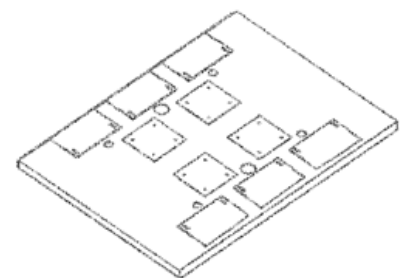

Flush Mount Bottom

Width	24" Deep	30" Deep	36" Deep	42" Deep	48" Deep
24"	FMB-A24X24-FHx	FMB-A24X30-FHx	FMB-A24x36-FHx	FMB-A24X42-FHx	FMB-A24X48-FHx
28"	FMB-A28X24-FHx	FMB-A28X30-FHx	FMB-A28x36-FHx	FMB-A28X42-FHx	FMB-A28X48-FHx

SC Series Cabinets Accessories

Shelves

Features

- 19" wide rack mount units
- Formed carbon steel construction for stiffness and strength
- Allows cable access in rear when used with appropriate frame
- 17" wide, mounting brackets use 1RMU of space
- 150 lb. weight capacity
- Roll-Out shelves use full ball bearing slides for full extension
- Vented versions available
- Choice of colors: Color Code = "x" Black (BLK) or IBM White (W)

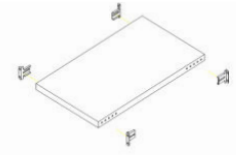

SWE2000-SF30D

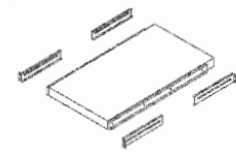

SWE2000-SR30D

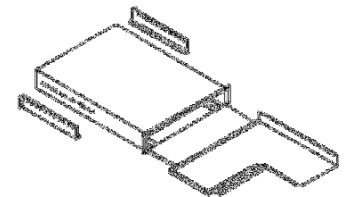

SWE2249

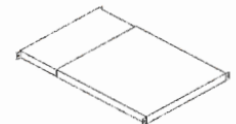

SWE2573

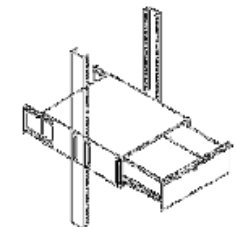

SWE836

Shelf Style	18" Deep	24" Deep	30" Deep	36" Deep
Fixed Equipment Shelf	SWE2000-SF18Dx	SWE2000-SF24Dx	SWE2000-SF30Dx	SWE2000-SF36Dx
	SWE2000-SFV18Dx (Vented)	SWE2000-SFV24Dx (Vented)	SWE2000-SFV30Dx (Vented)	SWE2000-SFV36Dx (Vented)
Roll-Out Shelf	SWE2000-SR18Dx	SWE2000-SR24Dx	SWE2000-SR30Dx	SWE2000-SR36Dx
	SWE2000-SRV18Dx (Vented)	SWE2000-SRV24Dx (Vented)	SWE2000-SRV30Dx (Vented)	SWE2000-SRV36Dx (Vented)
Monitor Shelf & Articulating KB Tray		SWE2249x		
Adjustable Shelf (20" to 32")		SWE2573x 100 lb. wt. capacity	SWE2573x 100 lb. wt. capacity	
		SWE2573-Vx (Vented)	SWE2573-Vx (Vented)	
Lockable Drawer (20" Deep)	SWE836x 75 lb. wt. capacity	SWE836x 75 lb. wt. capacity		

SC Series Cabinets Accessories

Vertical Cable Managers

Features

- Mounts to any SWDP cabinet frame in same track as mounting rails
- Provides a convenient cable run vertically
- Can be mounted on either side, in front or rear of cabinet
- All steel construction
- Choice of colors: Color Code = "x" Black (BLK) or IBM White (W)

Frame Height	Part #	Description
48"H (23U)	SWE722x	Vertical Cable Manager 1.62"W x 40.25"H
72"H (37U)	SWE720x	Vertical Cable Manager 1.62"W x 64.75"H
78"H (42U)	SWE725x	Vertical Cable Manager 1.62"W x 73.5"H
84"H (44U)	SWE721x	Vertical Cable Manager 1.62"W x 77" H
84"H (44U)	SWE721-3x3.5	Vertical Cable Manager 3" x 3.5" x 77"H



SWE721

Vertical Cable Lacing Bar

Features

- Neatly organizes cable bundles with slots provided for Velcro or other cable straps
- Creates quick cable management solutions for any SWDP cabinet series
- Available in 4 heights, 3.5" wide
- Formed 16 gauge steel construction
- Black Powder Coat finish

Part #	Description
SWE751BLK	Vertical Cable Lacing Bar - 3.5" W x 77"H (44U)
SWE752BLK	Vertical Cable Lacing Bar - 3.5"W x 40.25"H (23U)
SWE753BLK	Vertical Cable Lacing Bar - 3.5"W x 64.74"H (37U)
SWE754BLK	Vertical Cable Lacing Bar - 3.5"W x 73.5"H (42U)

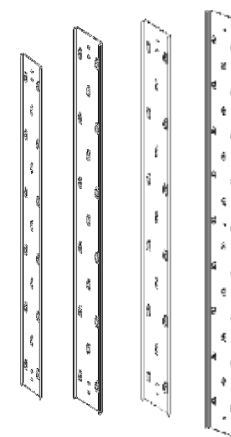

Vertical Cable Lacing Bar

SC Series Cabinets Accessories

Casters: SWE-ACS

Features

- Heavy duty roller bearing construction rated for 1000 lbs. per set
- Mounts to any SC Series frame

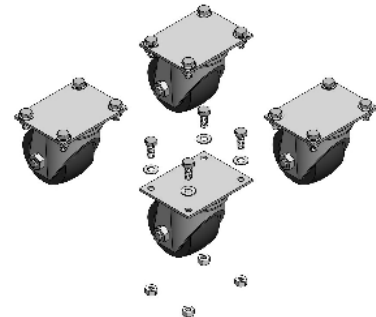

SWE-ACS

Vertical Copper Buss Bar: SWE2161

Part #	Description
SWE2161-36	Vert. Copper Buss Bar with 4 lugs, 48" or taller cabs
SWE2161-72	Vert. Copper Buss Bar with 8 lugs, 78" or taller cabs

Power Strips

Features

- Breaker protected, UL Listed
- Metal construction for durability

15 AMP	Description
SWE705-10TL	(10) 15 AMP outlets, 48"L, 15' cord, Twist Lock Plug
SWE705-16	(16) outlets, 48"L, 15' cord
SWE705-24-15A	(24) outlets, 70"L, 15' cord
SWE705-8	(8) outlets, 44"L, 15' cord
SWE705-RM	Rack Mount, (8) outlet, 15' cord
20 AMP	Description
SWE705-10-15TL	(10) outlets, 15" cord, L5P20 Twist Lock Plug, 48"L
SWE705-10-20A	(14) outlets, 15' cord, 20A plug, 48"L
SWE705-10-20ATL	(14) outlets, 15' cord, L5P20 Twist Lock Plug, 48"L
SWE705-24-20A	(24) outlets, 15' cord, 20A plug, 70"L
SWE705-24-20ATL	(24) outlets, 15' cord, L5P20 Twist Lock plug, 70"L
SWE705-20R-RM	Rack Mount, (8) outlet, 15 ft. cord

Vertical Mount
Power Strip

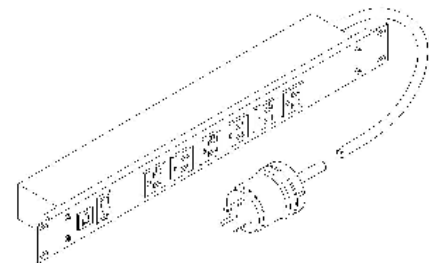
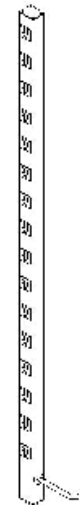

Rack Mount Power Strip

SC Series Cabinets Accessories

Frame Couplers: SC-FC

Features

- Top mount frame couplers install easily to factory pre-drilled frames
- Flat plate 2"W x 18" long enables (2) SC Series frames of the same height and depth to be bayed together
- Enables bayed units to be centered on raised floor tiles (no space between frames)
- Includes installation hardware
- Black (BLK) powder coat finish

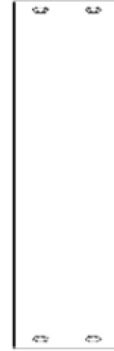

SC-FC

Fans: SWE706 Series

Features

- Can be mounted in any SWDP fan top or wall mount cabinet with fan holes
- Sealed bearings
- (2) finger guards included

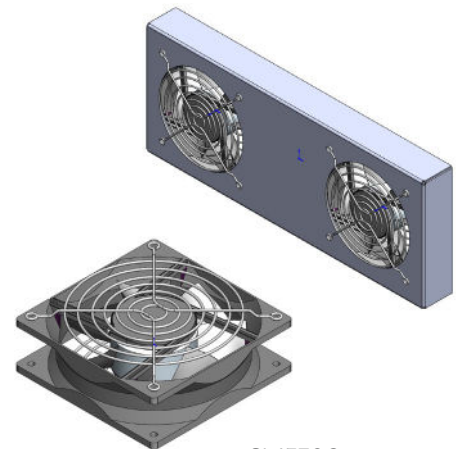

SWE706

Part #	Description
SWE706	110 CFM Axial Fan with 6' cord, 115V
SWE706-53CFM	53 CFM Axial Fan with 6' cord, 115V

PDU Vertical Mounting Bracket

Features

- Available in 3 heights
- Full length bracket attaches to cabinet frame to provide options for mounting vertical power distribution units
- Provides tie points for power cords
- Black Powder Coat finish

Part #	Description
SC-PDUBK-45U	PDU Vertical Mounting Bracket 77"
SC-PDUBK-42U	PDU Vertical Mounting Bracket 73.5"
SC-PDUBK-37U	PDU Vertical Mounting Bracket 64.75"



PDU Mounting Brackets

SC Series Cabinets

Vertical Exhaust Duct

Features

- Guides hot air away from cabinet top to a drop ceiling plenum or overhead duct work
- For use with SC Series cabinets 42" and 48"D – includes top panel with cutout
NOTE: MUST SPECIFY CABINET SIZE WHEN ORDERING SEPARATELY
- Telescopes to match ceiling height
- Top edge gaskets to create a seal around the opening in the drop ceiling
- Steel construction
- Complete with all mounting hardware
- Choice of colors: Color Code = "x" Black (BLK) or IBM White (W)

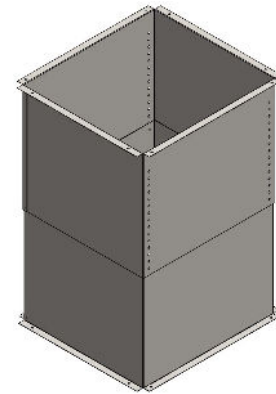

SC-4370x

Part #	Description
SC-4370x	Exhaust Duct 20" to 34"H
SC-4371x	Exhaust Duct 34" to 60"H

Air Flow Director: SC-AD series

Features

- Redirects exhaust airflow from the bottom of the cabinet towards the duct at the top

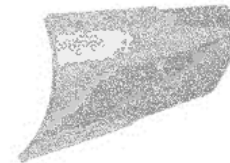

SC-AD-X

Part #	Description
SC-AD-24x	Fits 24"W cabinets
SC-AD-28	Fits 28"W cabinets

Air Dam Kit: SC-DK Series

Features

- Directs cool air entering the Server Cabinet Front Door and concentrates it to equipment
- Creates a barrier between the front and rear of the cabinet to prevent mixing of the cool air with the hot equipment exhaust air.
- Further enhances the hot/cold air system
- Complete with all mounting hardware

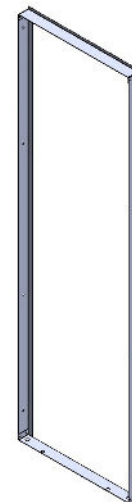

SC-DK

48" TALL SC	72" TALL SC	78" TALL SC	84" TALL SC
SC-DK-48	SC-DK-72	SC-DK-78	SC-DK-84
SC-DK-48-28	SC-DK-72-28	SC-DK-78-28	SC-DK-84-28